

Test Report

Report No. A2180042778101003

Page 1 of 11

Applicant SHENGYI TECHNOLOGY(SUZHOU) CO.,LTD.

Address 288# XINGLONG STREET, SUZHOU INDUSTRIAL PARK, JIANGSU PROVINCE

The following sample(s) and sample information was/were submitted and identified by/on the behalf of the client

Sample Name Copper Clad Laminate
Part No. S1000-2M
Color Red
Item No. L182312439
Material Epoxy Resin 、 Continuous Filament Fiber Glass 、 Copper
Sample Received Date Apr. 4, 2018
Testing Period Apr. 4, 2018 to Apr. 12, 2018

Test Requested As specified by client, to test Lead(Pb), Cadmium(Cd), Mercury(Hg), Hexavalent Chromium(Cr(VI)), Polybrominated Biphenyls(PBBs), Polybrominated Diphenyl Ethers (PBDEs), Arsenic(As), Beryllium(Be), Antimony(Sb), Fluorine (F), Chlorine (Cl), Bromine (Br), Iodine (I), Phthalates, Perfluorooctane Sulfonates (PFOS), Perfluorooctanoic Acid (PFOA), Bisphenol A (BPA), Polyvinyl Chloride (PVC), Hexabromocyclododecane (HBCDD), Tetrabromobisphenol A in the submitted sample(s).

Test Method Please refer to the following page(s).

Test Result(s) Please refer to the following page(s).

Tested By  Jie

Reviewed By Dong Yong min

Approved By Su Hongwei

Date Apr. 12, 2018

Su Hongwei
Senior Laboratory
Centre Testing International (Shanghai) Co., Ltd.

No. R198691944
No. 1996, Xinqinqiao Road, Pudong New District, Shanghai, China

Test Report

Report No. A2180042778101003

Page 2 of 11

Test Method

Tested Item(s)	Test Method	Measured Equipment(s)
Lead(Pb)	IEC 62321-5:2013	ICP-OES
Cadmium(Cd)	IEC 62321-5:2013	ICP-OES
Mercury(Hg)	IEC 62321-4:2013+AMD1:2017 CSV	ICP-OES
Hexavalent Chromium(Cr(VI))	IEC 62321-7-2:2017 and/or determination of Total Chromium by IEC 62321-5:2013	UV-Vis/ICP-OES
Polybrominated Biphenyls(PBBs)	IEC 62321-6:2015	GC-MS
Polybrominated Diphenyl Ethers (PBDEs)	IEC 62321-6:2015	GC-MS
Phthalates(DBP, BBP, DEHP, DIBP)	IEC 62321-8:2017	GC-MS
Arsenic(As)	Refer to US EPA 3052:1996 & US EPA 6010D:2014	ICP-OES
Beryllium(Be)	Refer to US EPA 3052:1996 & US EPA 6010D:2014	ICP-OES
Antimony(Sb)	Refer to US EPA 3052:1996 & US EPA 6010D:2014	ICP-OES
Fluorine (F)	Refer to EN 14582:2016	IC
Chlorine (Cl)	Refer to EN 14582:2016	IC
Bromine (Br)	Refer to EN 14582:2016	IC
Iodine (I)	Refer to EN 14582:2016	IC
Perfluorooctanoic Acid (PFOA)	Refer to US EPA 3550C:2007 & US EPA 8321B:2007	LC-MS-MS
Perfluorooctane Sulfonates (PFOS)	Refer to US EPA 3550C:2007 & US EPA 8321B:2007	LC-MS-MS
Bisphenol A (BPA)	Refer to US EPA 3550C:2007 & US EPA 8321B:2007	LC-MS-MS
Polyvinyl Chloride (PVC)	JY/T 001:1996	FT-IR
Hexabromocyclododecane (HBCDD)	Refer to US EPA 3550C:2007 & US EPA 8270D:2014	GC-MS
Tetrabromobisphenol A (TBBP-A)	Refer to US EPA 3550C:2007 & US EPA 8270D:2014	LC-MS-MS
Phthalates (DNOP, DINP, DIDP, DMP, DEP, DPP, DCHP, DIOP, DNP, DNHP, DMEP, DIPP, DHNUP, DIHP)	Refer to EN 14372:2004(E)	GC-MS

Test Report

Report No. A2180042778101003

Page 3 of 11

Test Result(s)

Tested Item(s)	Result	MDL
Lead(Pb)	N.D.	2 mg/kg
Cadmium(Cd)	N.D.	2 mg/kg
Mercury(Hg)	N.D.	2 mg/kg
Hexavalent Chromium(Cr(VI))	N.D.	8 mg/kg
Tested Item(s)	Result	MDL
Polybrominated Biphenyls(PBBs)		
Monobromobiphenyl	N.D.	5 mg/kg
Dibromobiphenyl	N.D.	5 mg/kg
Tribromobiphenyl	N.D.	5 mg/kg
Tetrabromobiphenyl	N.D.	5 mg/kg
Pentabromobiphenyl	N.D.	5 mg/kg
Hexabromobiphenyl	N.D.	5 mg/kg
Heptabromobiphenyl	N.D.	5 mg/kg
Octabromobiphenyl	N.D.	5 mg/kg
Nonabromobiphenyl	N.D.	5 mg/kg
Decabromobiphenyl	N.D.	5 mg/kg
Tested Item(s)	Result	MDL
Polybrominated Diphenyl Ethers (PBDEs)		
Monobromodiphenyl ether	N.D.	5 mg/kg
Dibromodiphenyl ether	N.D.	5 mg/kg
Tribromodiphenyl ether	N.D.	5 mg/kg
Tetrabromodiphenyl ether	N.D.	5 mg/kg
Pentabromodiphenyl ether	N.D.	5 mg/kg
Hexabromodiphenyl ether	N.D.	5 mg/kg
Heptabromodiphenyl ether	N.D.	5 mg/kg
Octabromodiphenyl ether	N.D.	5 mg/kg
Nonabromodiphenyl ether	N.D.	5 mg/kg
Decabromodiphenyl ether	N.D.	5 mg/kg

Test Report

Report No. A2180042778101003

Page 4 of 11

Test Result(s)

Tested Item(s)	Result	MDL
Phthalates (DBP, BBP, DEHP, DIBP)		
Dibutyl phthalate(DBP) CAS#:84-74-2	N.D.	50 mg/kg
Butyl benzyl phthalate(BBP) CAS#:85-68-7	N.D.	50 mg/kg
Di-(2-ethylhexyl) phthalate(DEHP) CAS#:117-81-7	N.D.	50 mg/kg
Diisobutyl phthalate(DIBP) CAS#:84-69-5	N.D.	50 mg/kg
Tested Item(s)		
Arsenic(As)	N.D.	10 mg/kg
Beryllium(Be)	N.D.	10 mg/kg
Antimony(Sb)	N.D.	10 mg/kg
Tested Item(s)		
Fluorine(F)	654 mg/kg	10 mg/kg
Chlorine(Cl)	297 mg/kg	10 mg/kg
Bromine(Br)	27543 mg/kg	10 mg/kg
Iodine(I)	N.D.	10 mg/kg

Test Report

Report No. A2180042778101003

Page 5 of 11

Test Result(s)

Tested Item(s)	Result	MDL
Phthalates		
Di-n-octyl phthalate(DNOP) CAS#:117-84-0	N.D.	50 mg/kg
Di-isononyl phthalate(DINP) CAS#:28553-12-0,68515-48-0	N.D.	50 mg/kg
Di-iso-decyl phthalate(DIDP) CAS#:26761-40-0,68515-49-1	N.D.	50 mg/kg
Dimethyl phthalate(DMP) CAS#:131-11-3	N.D.	50 mg/kg
Diethyl phthalate(DEP) CAS#:84-66-2	N.D.	50 mg/kg
Dipentyl phthalate(DPP) CAS#:131-18-0	N.D.	50 mg/kg
Dicyclohexyl phthalate(DCHP) CAS#:84-61-7	N.D.	50 mg/kg
Diisooctyl phthalate(DIOP) CAS#:27554-26-3	N.D.	50 mg/kg
Dinonyl phthalate(DNP) CAS#:84-76-4	N.D.	50 mg/kg
Di-n-hexyl phthalate(DNHP) CAS#:84-75-3	N.D.	50 mg/kg
Bis(2-methoxyethyl) phthalate(DMEP) CAS#:117-82-8	N.D.	50 mg/kg
Diisopentylphthalate(DIPP) CAS#:605-50-5	N.D.	50 mg/kg
*1,2-Benzenedicarboxylic acid, di-(C7-11)-branched and linear alkyl esters(DHNUP) CAS#:68515-42-4	N.D.	100 mg/kg
*1,2-Benzenedicarboxylic acid, di-C6-8-branched alkyl esters, C7-rich(DIHP) CAS#:71888-89-6	N.D.	100 mg/kg
Tested Item(s)	Result	MDL
Perfluorooctane Sulfonates(PFOS)	N.D.	5 mg/kg
Tested Item(s)	Result	MDL
Perfluorooctanoic Acid(PFOA)	N.D.	5 mg/kg
Tested Item(s)	Result	MDL
Bisphenol A(BPA)	N.D.	1 mg/kg

Test Report

Report No. A2180042778101003

Page 6 of 11

Test Result(s)

Tested Item(s)	Result	MDL
Polyvinyl Chloride(PVC)	Negative	/
Tested Item(s)	Result	MDL
Hexabromocyclododecane(HBCDD)	N.D.	5 mg/kg
Tested Item(s)	Result	MDL
Tetrabromobisphenol A(TBBP-A)	N.D.	5 mg/kg

Tested Sample/Part Description Cupreous clad laminate

Remark: The sample(s) had been dissolved totally tested for Lead, Cadmium, Mercury, Arsenic, Beryllium, Antimony.

-MDL = Method Detection Limit

-N.D. = Not Detected (<MDL)

-mg/kg = ppm = parts per million

-Negative = Not contained Polyvinyl Chloride(PVC)

-*= In view of the substances are established as UVCB substances (substances of unknown or variable composition, complex reaction products or biological materials) consisting of different and variable constituents, the test results are calculated based on the main constituents of the representative compounds for substances.

Test Report

Report No. A2180042778101003

Page 7 of 11

Test Process

1. Lead(Pb), Cadmium(Cd), Chromium(Cr)

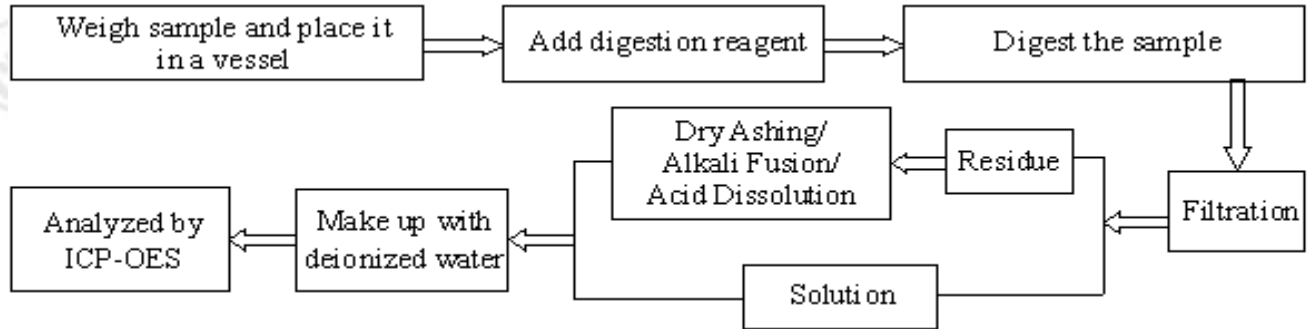

2. Mercury(Hg)

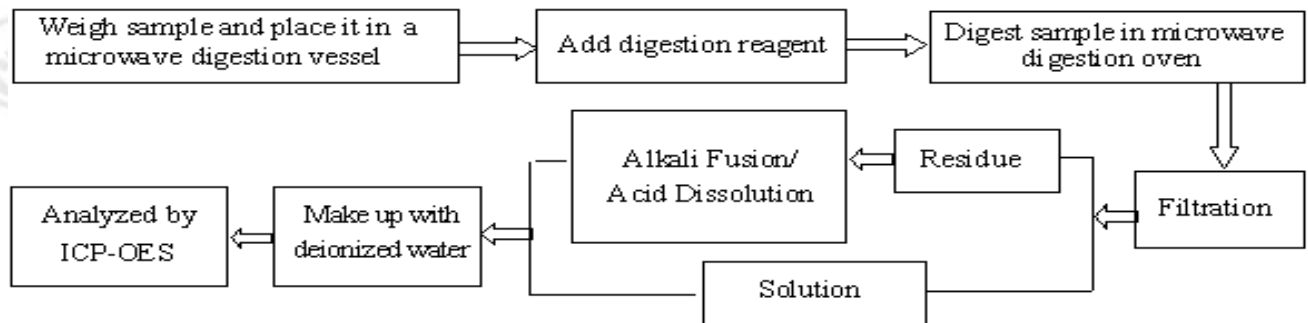

3. Hexavalent Chromium(Cr(VI))

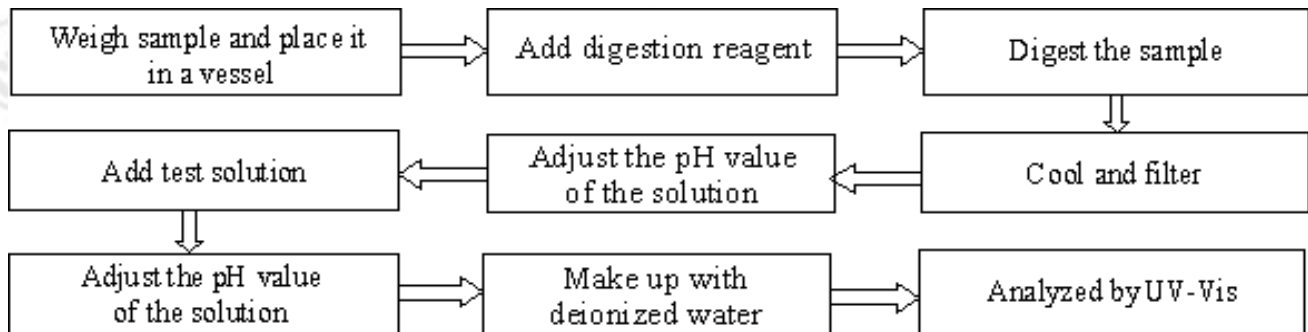

4. Polybrominated Biphenyls(PBBs), Polybrominated Diphenyl Ethers (PBDEs)

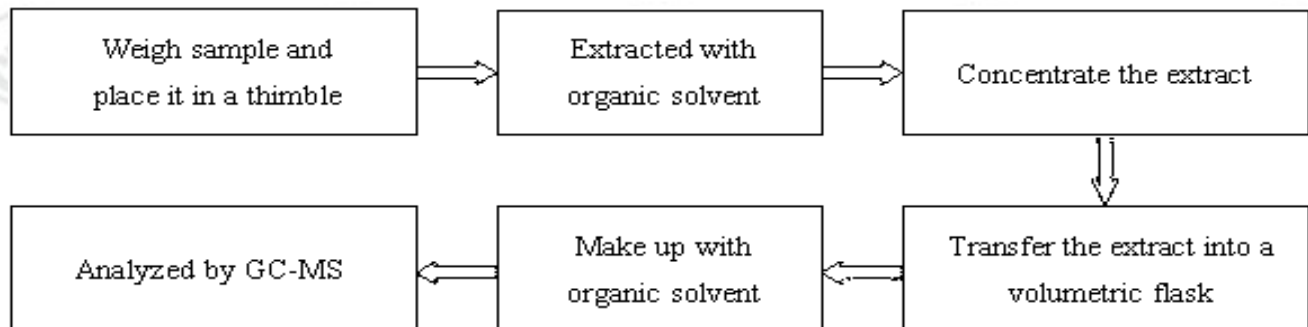

Test Report

Report No. A2180042778101003

Page 8 of 11

5. Phthalates

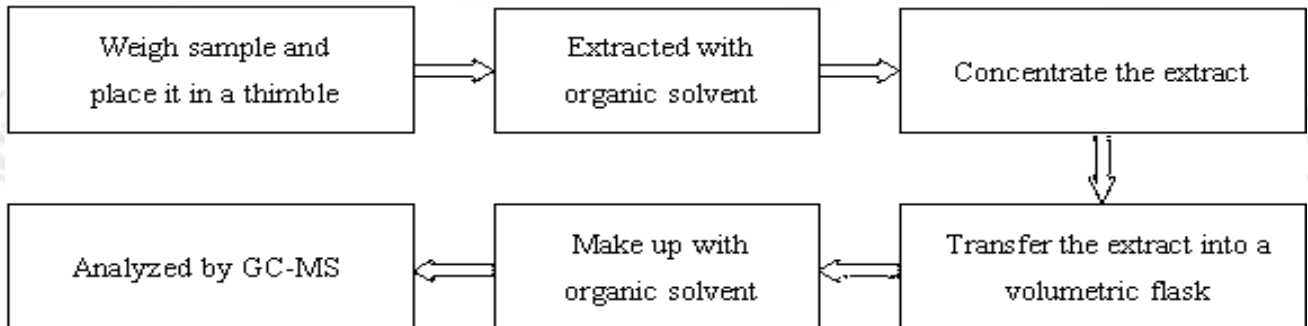

6. Arsenic(As), Beryllium(Be), Antimony(Sb)

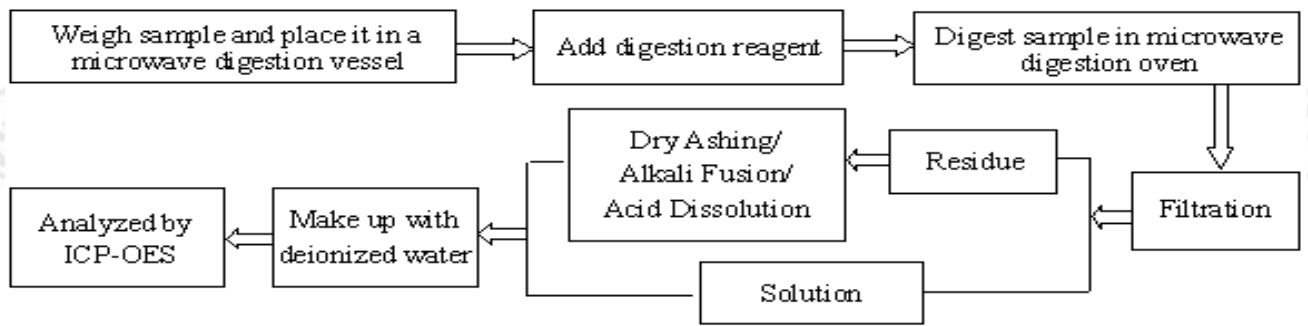

7. Fluorine (F), Chlorine (Cl), Bromine (Br), Iodine (I)

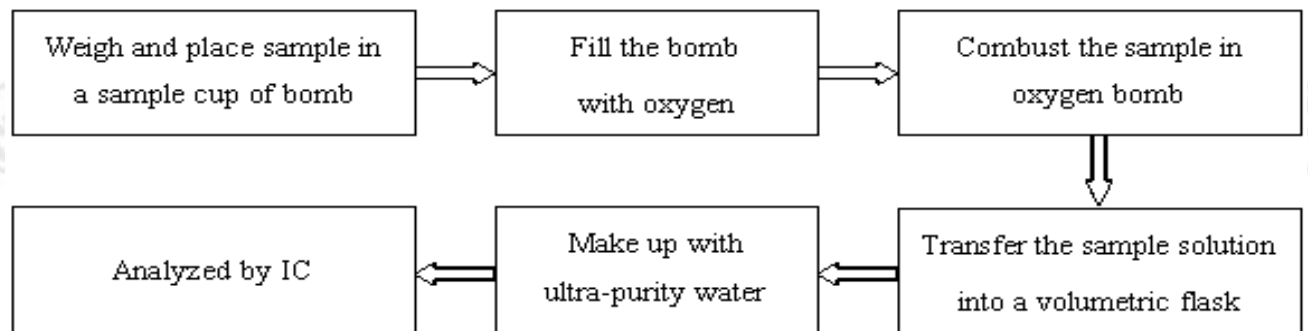

Test Report

Report No. A2180042778101003

Page 9 of 11

8. Perfluorooctane Sulfonates (PFOS), Perfluorooctanoic Acid (PFOA)

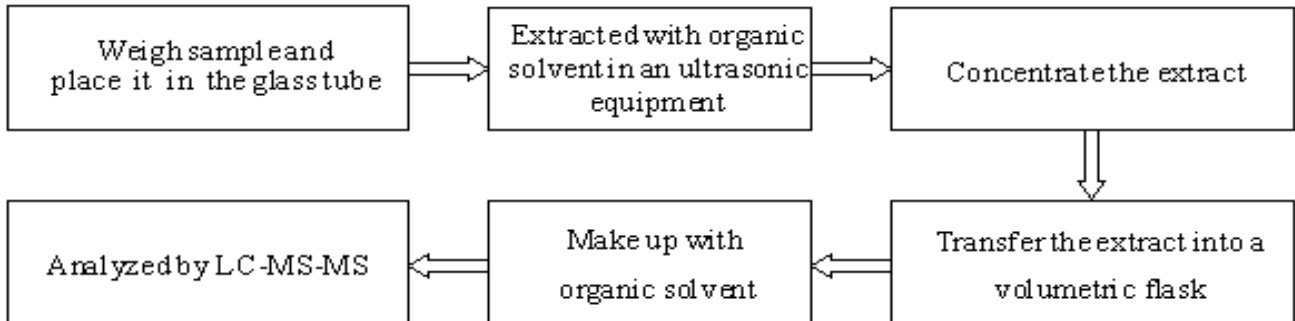

9. Bisphenol A (BPA)

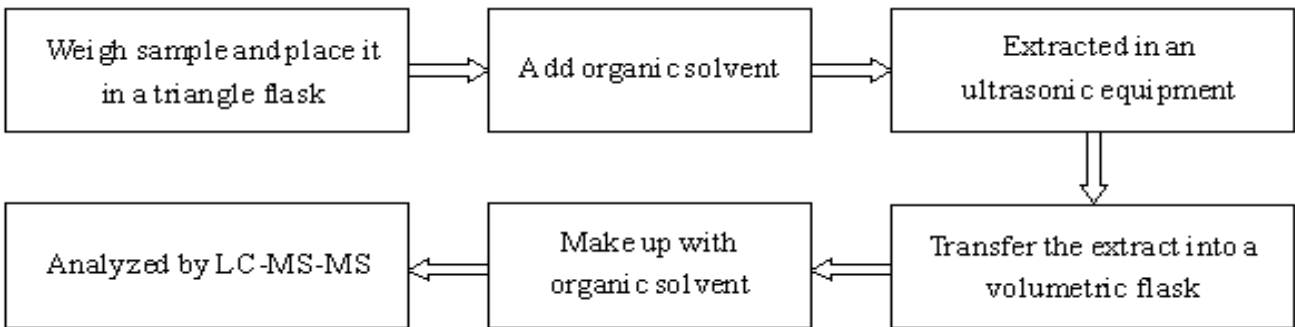

10. Polyvinyl Chloride (PVC)

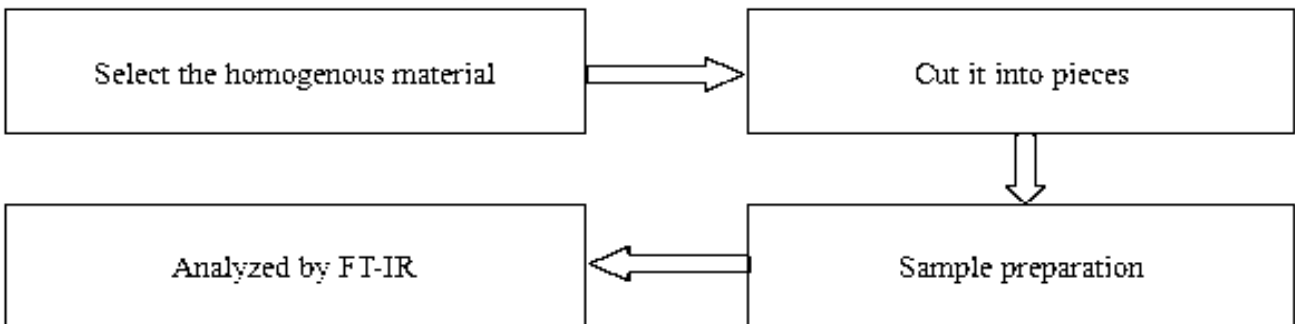

11. Hexabromocyclododecane (HBCDD)

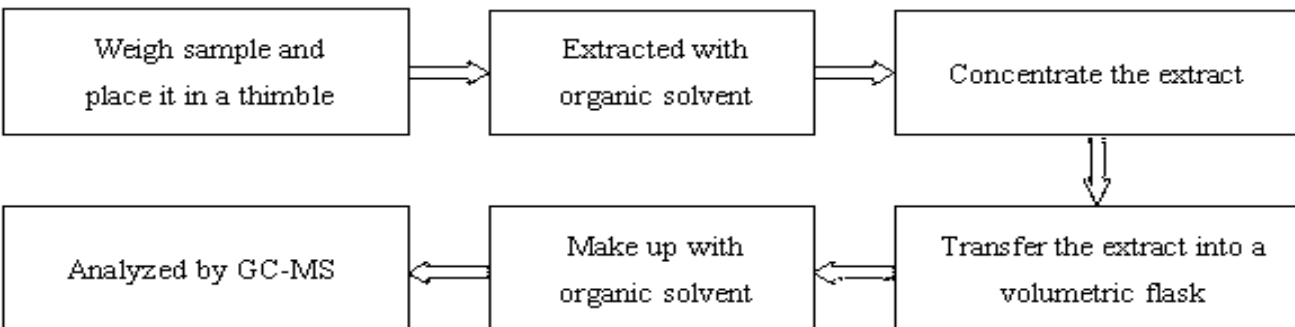

Test Report

Report No. A2180042778101003

Page 10 of 11

12. Tetrabromobisphenol A (TBBP-A)

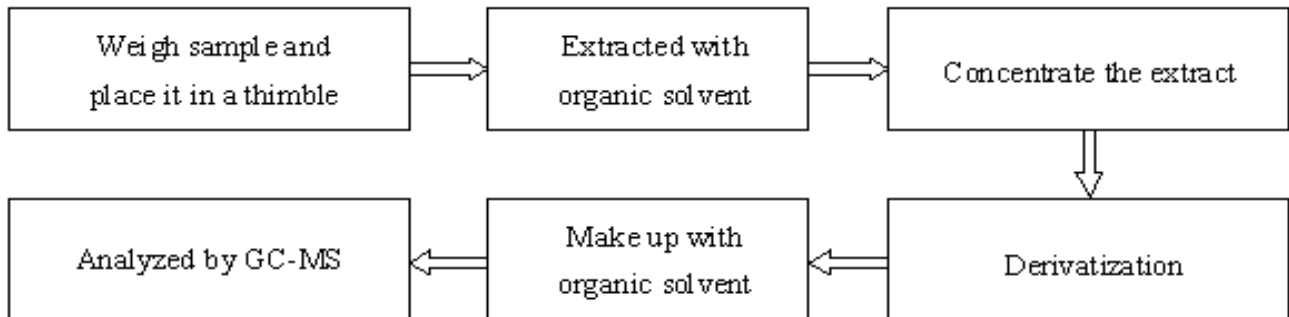

Test Report

Report No. A2180042778101003

Page 11 of 11

Photo(s) of the sample(s)

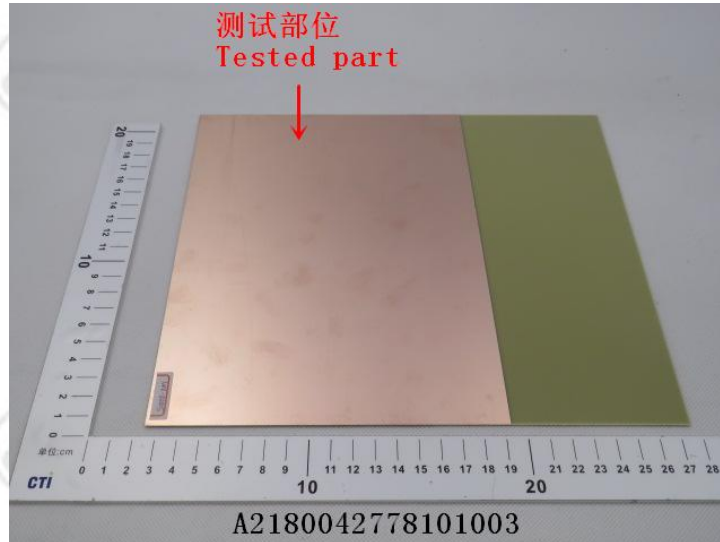

*** End of report ***

Statement:

1. This report is considered invalidated without approval signature, special seal and the seal on the perforation;
2. The sample(s) and sample information was/were provided by the client who should be responsible for the authenticity which CTI hasn't verified;
3. The result(s) shown in this report refer(s) only to the sample(s) tested;
4. Without written approval of CTI, this report can't be reproduced except in full;
5. In case of any discrepancy between the English version and Chinese version of the testing reports (if generated), the Chinese version shall prevail.